

Z716-1

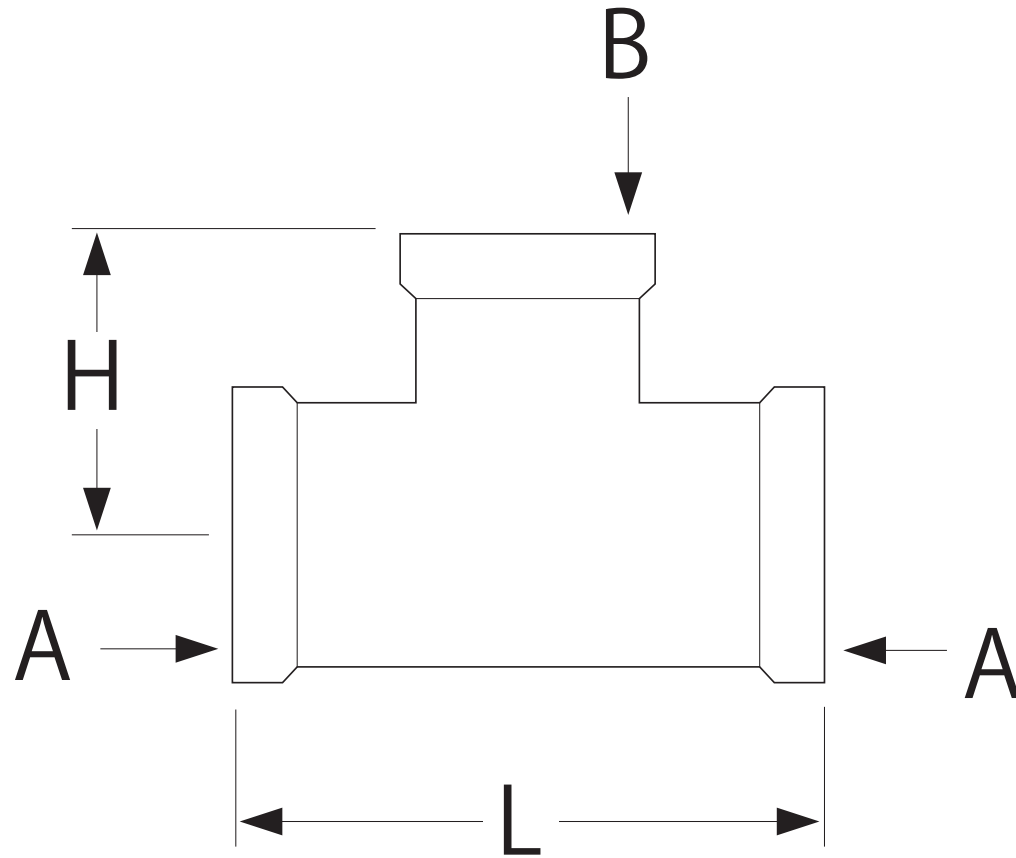

	L	H	A	B
1	58	30	Rc3/4	Rc1/2